

## MonoRail Spot

LED for Display, Cabinet, Furniture

### Slide and Swivel Mini LED Spotlight



- Compatible and linkable with MonoRail system
- Slide and swivel mini LED spotlight
- Suitable for furniture and showcase application
- Simple Plug & Play connection to the power track
- Available in silver or black
- To be used with constant voltage DC 24V driver





### Various options

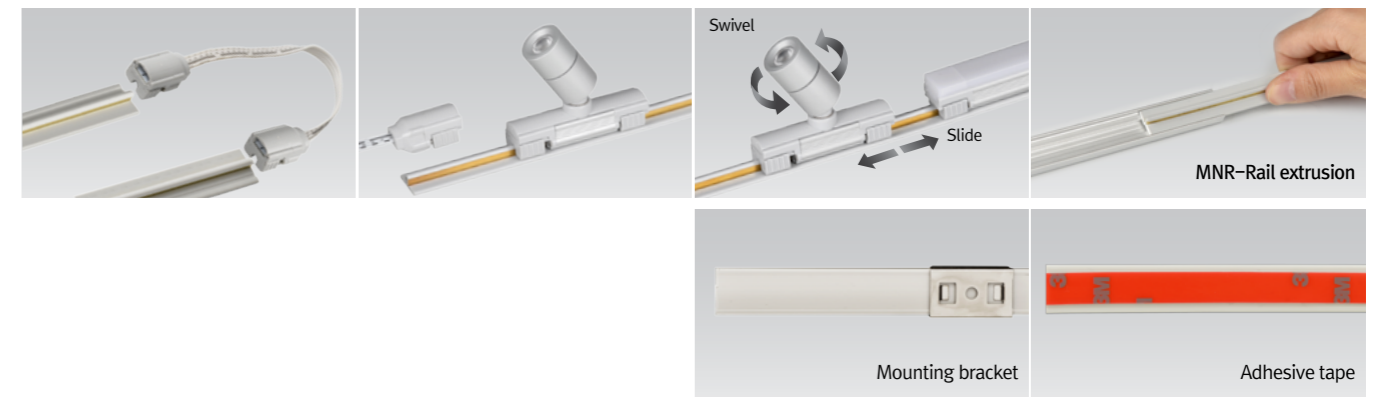

### Installation

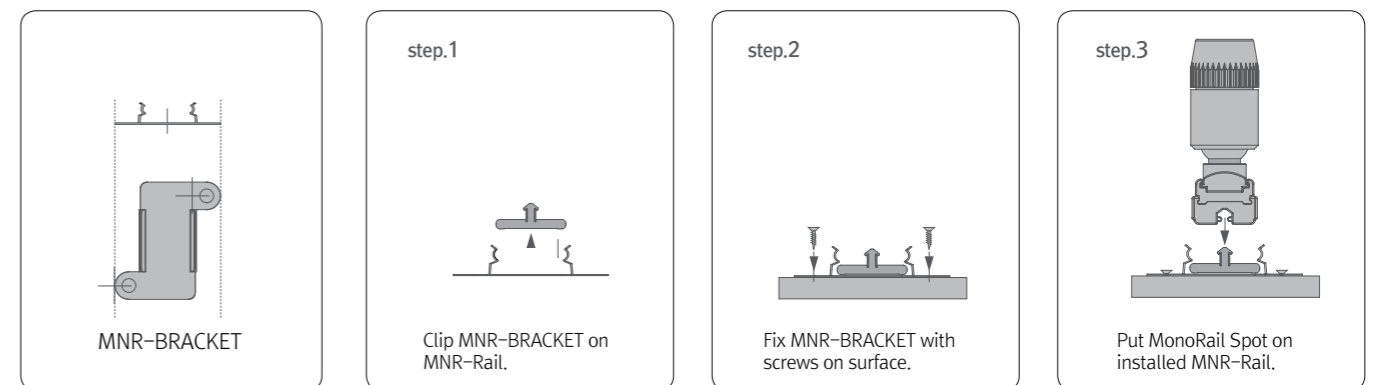

### Max. connection

- MonoRail Spot :180W in one row (Single power feed)
- LED Driver

LED Driver Model Name	Max. units for LED Driver			
	24V/15W	24V/30W	24V/75W	24V/200W
MRS1 40K-24V-SV	10	20	52	140

### Specification

Model Name	Color	Power Input	Lamp Power	Luminous Flux	Efficiency	Color Rendering	Available Color	Beam Angle	Operating Temperature
MRS1 40K-24V-SV	Silver	DC24V	1W	65 lm	65 lm/W	Ra > 85	2,700K/3,000K/4,000K/6,000K	15°, 30°	0-45°C
MRS1 40K-24V-BK	Black	DC24V	1W	65 lm	65 lm/W	Ra > 85	2,700K/3,000K/4,000K/6,000K	15°, 30°	0-45°C

## Dimension

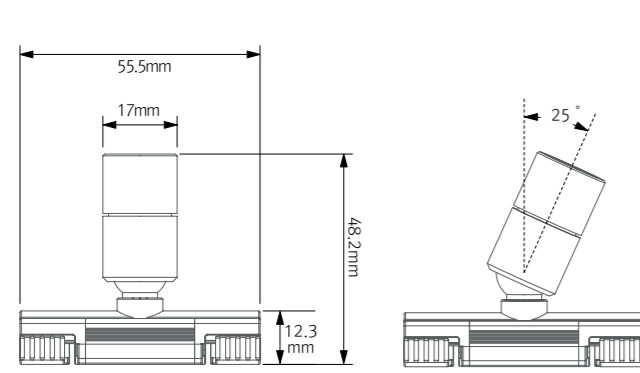

Model Name	A (mm)	B (mm)	C (mm)
FLC15-24V/T	121	45	16
FLC30-24V/T	150	41	31
FLC75-24V/T	180	60	32

### \* LED Converter

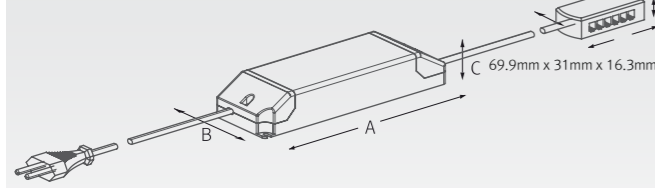

Model Name	A (mm)	B (mm)	C (mm)
FLC200-24V/T	228	68	39

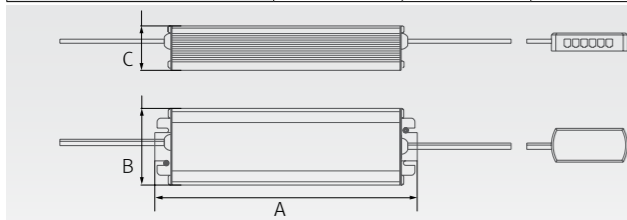

### \* MNR-Rail extrusion pole

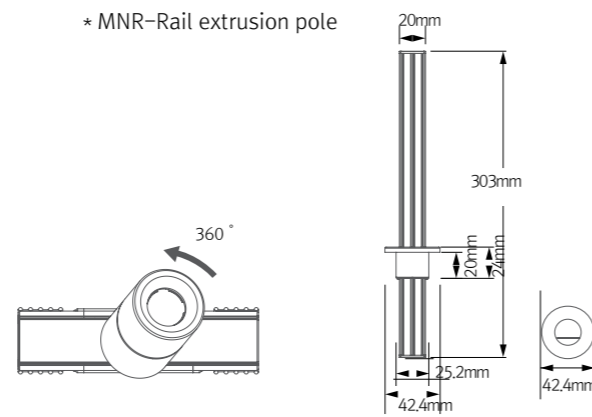

### \* MNR-Rail extrusion line

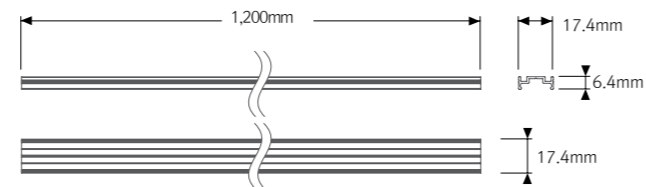

### \* MNR-Rail extrusion corner

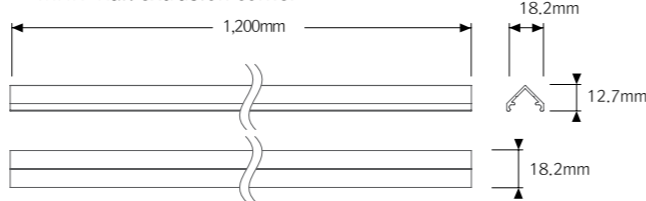

## Accessories



### Ⓐ MonoRail Spot

Beam angle	Silver	Black
15°	MRS1 40K-24V-SV-15	MRS1 40K-24V-BK-15
30°	MRS1 40K-24V-SV-30	MRS1 40K-24V-BK-30



### Ⓑ Power supply track : MNR-Rail (20m)

Power supply track in Roll without adhesive  
Color : White, Gray, Black

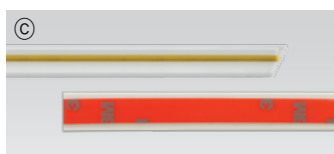

### Ⓒ Power supply track : MNR-Rail (1.2m)

Power supply track with adhesive tape  
Color : White, Gray, Black

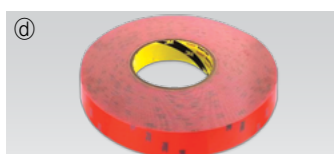

### Ⓓ Adhesive tape

Adhesive tape for MNR-Rail (16.5m)



### Ⓔ Power supply cable to the MNR-Rail : MNRPC (2500mm)

120W in one row (w/ terminal block)  
180W in one row (w/o terminal block)

### Ⓘ Connecting cable between MNR-Rail

MNRPTC	MNRPTC1	MNRPTC2	MNRPTC4	MNRPTC6
150mm(6inch)	300mm(1feet)	600mm(1feet)	1200mm(4feet)	1800mm(6feet)

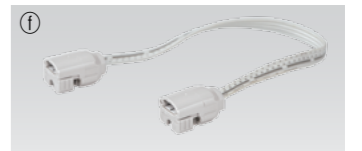

### Ⓣ LED Driver with 12way distributor, with power cord (1800mm)

Part NO	FLC15-24V/T	FLC30-24V/T	FLC75-24V/T
Capacity	24V/15W	24V/30W	24V/75W



### Ⓢ LED Driver : FLC200-24V/T (200W 24V)

LED Driver With 12way distributor

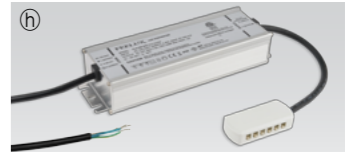

### Ⓣ MonoRail bracket : MNR-BRACKET (standard)



### Ⓣ MonoRail bracket : MNR-BRACKET1 (optional)

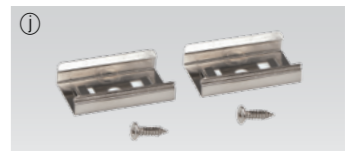

### Ⓚ Door and motion detection sensor (DC) : FLS-M24V

Voltage : DC 24V

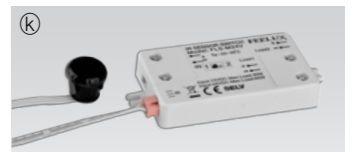

### Ⓛ Human-body detection sensor (DC) : FLS-P24V

Voltage : DC 24V

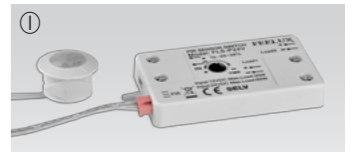

### Ⓜ MNR-Rail extrusion line (1.2m)

Silver	Black
MNR-EXL-SV	MNR-EXL-BK
Without MNR-Rail	

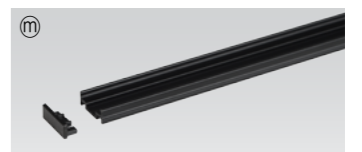

### Ⓨ MNR-Rail extrusion corner (1.2m)

Silver	Black
MNR-EXC-SV	MNR-EXC-BK
Without MNR-Rail	

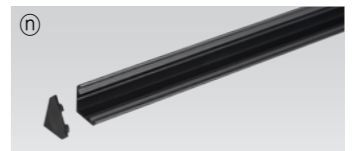

### Ⓩ MNR-Rail extrusion pole (300mm)

Silver	Black
MNR-EXP-SV	MNR-EXP-BK
With MNR-Rail	

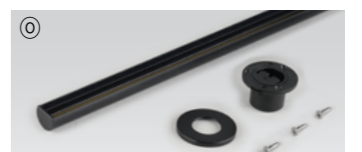

### ⓐ End cap : MNR-CAP

Color : White, Gray, Black

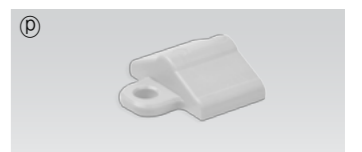

### ⓑ MNR-Rail protection cover : MNR-Rail cover

