

FLX Stix HDV

LED for Display, Cabinet, Furniture & Cove

Little light, Bigger punch!!



- Super Slim linear LED with high output
- Quick connection system between fixtures
- Many lengths available
- Various mounting methods including magnetic
- To be used with constant voltage DC 24V driver
- Dimmable with available accessories





Various options

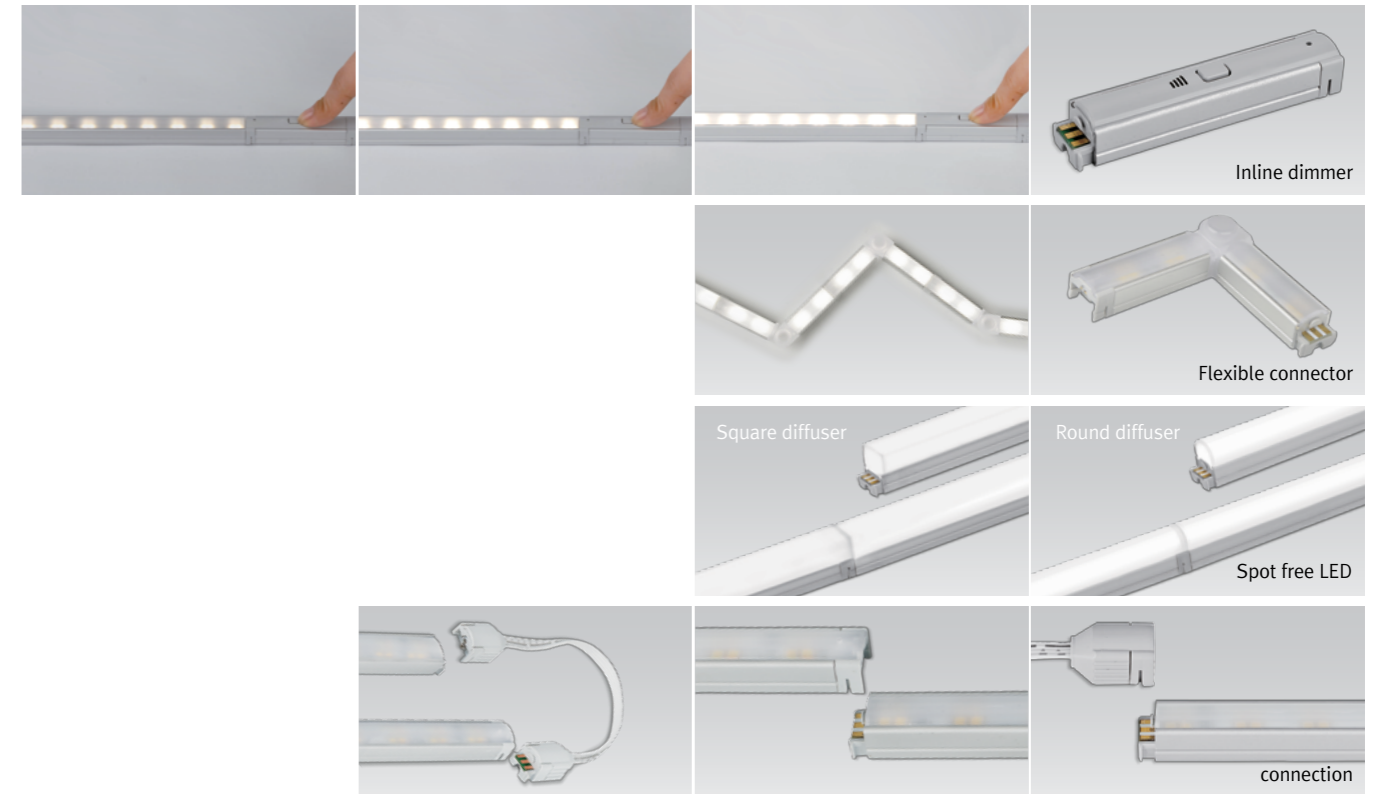

FLX Stix HDV High Output

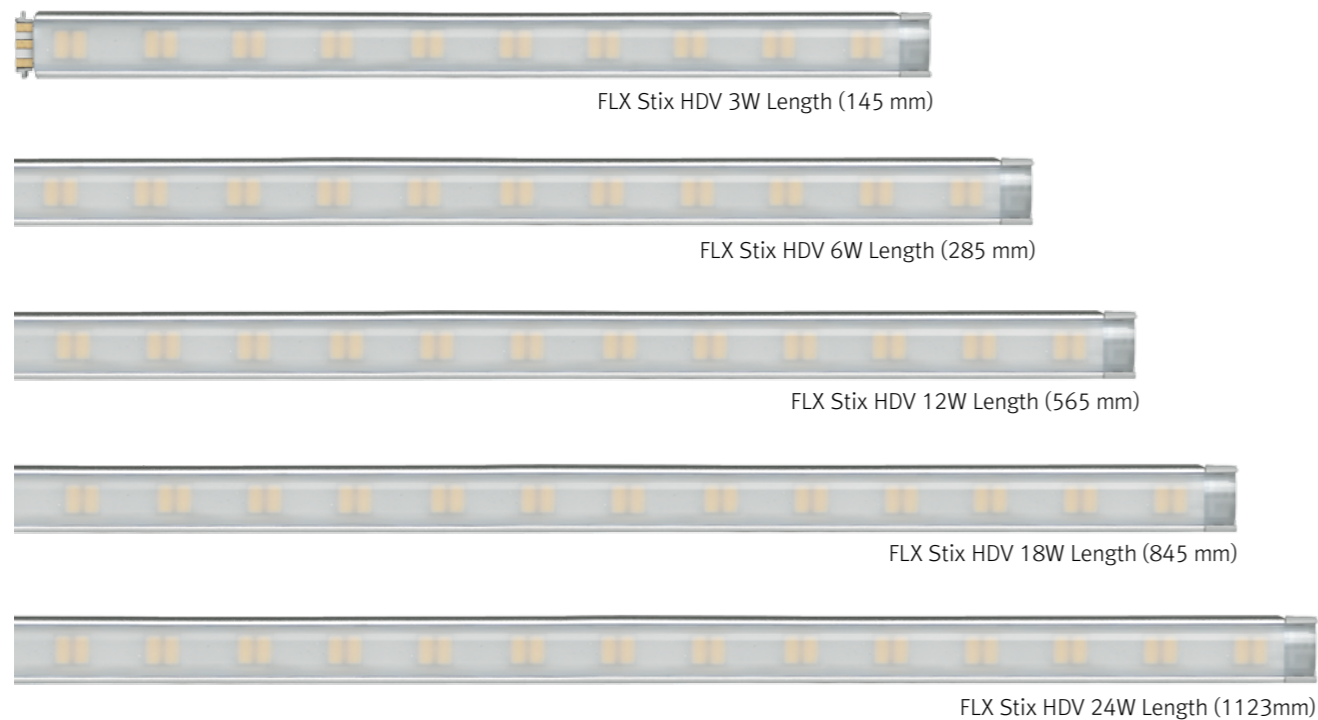

Installation

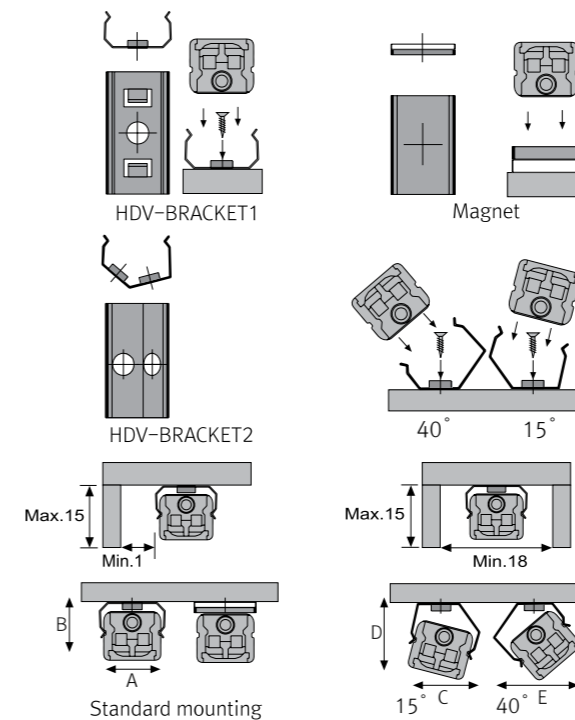

Max. connection

- FLX Stix HDV : 75W in one row(single power feed)
- LED Driver

LED Driver Model Name	Max. units for LED Driver			
	24V/15W	24V/30W	24V/75W	24V/200W
HDV3 40K-24V	5	10	25	66
HDV6 40K-24V	2	5	12	33
HDV12 40K-24V	1	2	6	16
HDV18 40K-24V	-	1	4	11
HDV24 40K-24V	-	1	3	8

- W/ Bracket

	A(mm)	B(mm)	C(mm)	D(mm)	E(mm)	F(mm)
Flat type	16.8	14.2	17.5	16.5	19.1	17.5
Round type	16.8	22.1	18.8	24.4	23.4	22.9
Square type	16.8	22.6	21.3	26.2	25.7	25.7

Specification

Model Name	Power Input	Lamp Power	Luminous Flux	Efficiency	Color Rendering	Available Color	Operating Temperature
HDV3 40K-24V	DC24V	3W	255lm	85 lm/W	Ra > 85	2,700K/3,000K/3,500K/4,000K/6,000K	0-45°C
HDV6 40K-24V	DC24V	6W	510lm	85 lm/W	Ra > 85	2,700K/3,000K/3,500K/4,000K/6,000K	0-45°C
HDV12 40K-24V	DC24V	12W	1,020lm	85 lm/W	Ra > 85	2,700K/3,000K/3,500K/4,000K/6,000K	0-45°C
HDV18 40K-24V	DC24V	18W	1,530lm	85 lm/W	Ra > 85	2,700K/3,000K/3,500K/4,000K/6,000K	0-45°C
HDV24 40K-24V	DC24V	24W	2,040lm	85 lm/W	Ra > 85	2,700K/3,000K/3,500K/4,000K/6,000K	0-45°C

Dimension

Model Name	Power Input (V)	Lamp Power (W)	A (mm)	B (mm)	C (mm)	D (mm)	E (mm)	F (mm)	G (mm)
HDV340K-24V	DC 24	2.9	140	145	162	16	14	15	12.5
HDV640K-24V	DC24	5.8	280	285	302	16	14	15	12.5
HDV1240K-24V	DC 24	11.6	560	565	582	16	14	15	12.5
HDV1840K-24V	DC 24	17.4	840	845	862	16	14	15	12.5
HDV2440K-24V	DC 24	23.2	1,118	1,123	1,140	16	14	15	12.5

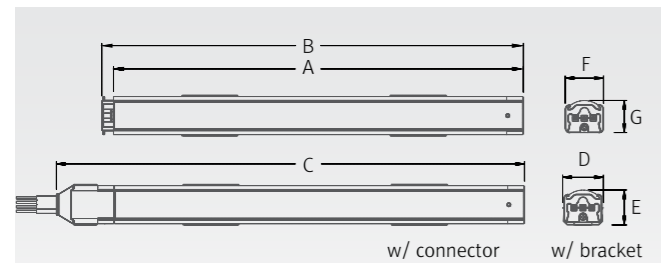

Model Name	A (mm)	B (mm)	C (mm)
FLC15-24V/T	121	45	16
FLC30-24V/T	150	41	31
FLC75-24V/T	180	60	32

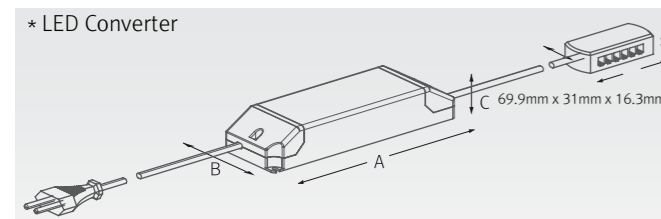

Model Name	A (mm)	B (mm)	C (mm)
FLC200-24V/T	228	68	39

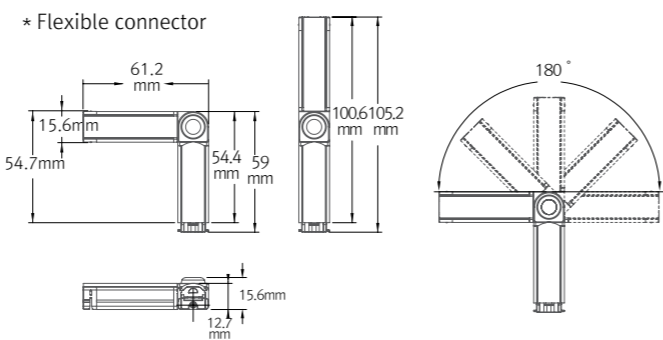
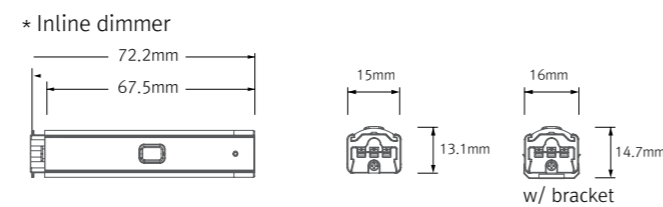
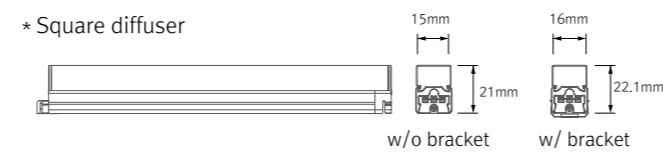
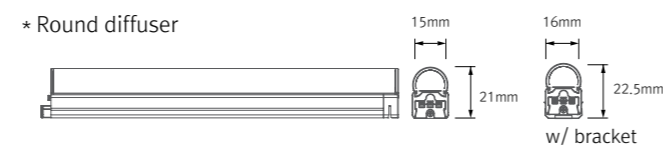
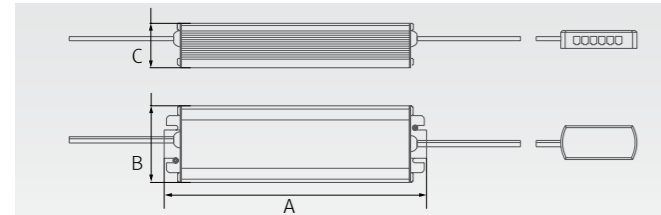

Accessories

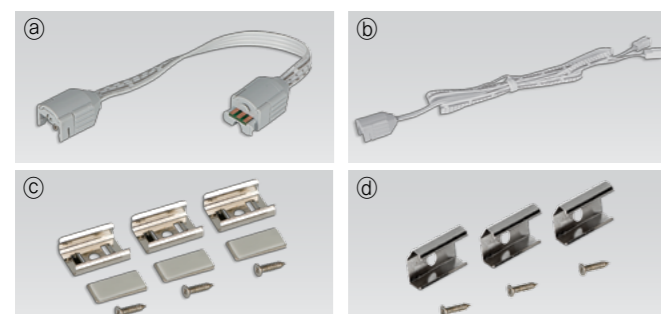

Ⓐ Connecting cables (Between FLX Stix HDV & FLX Stix HDV)

HDVPTC	HDVPTC1	HDVPTC2	HDVPTC4	HDVPTC6
150mm(6inch)	300mm(1feet)	600mm(2feet)	1200mm(4feet)	1800mm(6feet)

Ⓑ Power cable : HDVPC

Power cable 2500mm (Between FLX Stix HDV & 6-way distributor)

Ⓒ Mounting bracket : HDV-BRACKET1

Included in fixture
 HDV-BRACKET1(A) : 1set = 2pcs
 HDV-BRACKET1(B) : 1set = 3pcs

Ⓓ Angle bracket (15° & 40°) : HDV-BRACKET2

HDV-BRACKET2(A) : 1set = 2pcs
 HDV-BRACKET2(B) : 1set = 3pcs

Ⓔ Sidefeed for seamless extension (3W) : HDV3 40K-24V-S

The dimension is the same as HDV3 40K-24V
 Powered only through cable, no power supply on the input connector



Ⓕ Connector : HDV2 40K-24V-FLEX

FLX Stix HDV Flexible connector (2W)



Ⓖ End cap : HDV-CAP

Included in fixture



Ⓗ LED Driver with 12way distributor, with power cord (1800mm)

Part No	FLC15-24V/T	FLC30-24V/T	FLC75-24V/T
Capacity	15W 24V	30W 24V	75W 24V



Ⓘ LED Driver : FLC200-24V/T (200W 24V)

LED Driver With 12way distributor



Ⓙ Dimming Interface (1-10V) : FDC-L10

Max. 100W (100W/CH, 1CH)



Ⓚ Dimming Interface(0-10/1-10,DMX512)

FDA-L2M0 : Max. 200W (100W/CH, 2CH)
 FDA-L5M : Max. 200W (100W/CH, 5CH)



Ⓛ Inline dimmer : HDVDIM

Max 75W in a row



Ⓜ Round diffuser

HDV3CVRM	HDV6CVRM	HDV12CVRM	HDV18CVRM	HDV24CVRM
3W	6W	12W	18W	24W

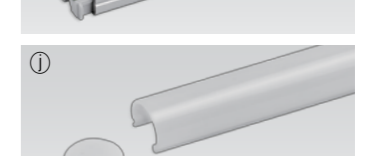

Ⓨ Square diffuser

HDV3CVSM	HDV6CVSM	HDV12CVSM	HDV18CVSM	HDV24CVSM
3W	6W	12W	18W	24W



Ⓩ Door and motion detection sensor : FLS-M24V

Voltage : DC 24V



ⓐ Human-body detection sensor : FLS-P24V

Voltage : DC 24V

